







-  Conventional marking technology
-  Scribe, stylus and dot-peening marking technology
-  Type-wheel marking technology
-  Laser-marking technology
-  Traceability
-  Special-purpose machines

Numberinghead

Technical data sheet

ANPW numbering head

Automatically adjustable

- By actuating the switching flap, forwarding takes place automatically after each marking stroke
- Character heights from 1.5 – 8 mm



VNPW numbering head

Manually adjustable via locking lever

- Actuating the lever releases the locking of the wheels, after which they can be brought into the desired position both forwards and backwards.
- Character heights from 1.5 – 8 mm



TNPW numbering head

Manually adjustable via button lever

- Actuating the lever shifts the wheels one position further.
- Character heights from 1.5 – 8 mm









MNPW numbering head

Manually adjustable

- The bolt locks the wheels in the desired position
- Particularly suitable for handheld stamping units
- Character heights from 1.5 – 5 mm



-  Conventional marking technology
-  Scribe, stylus and dot-peening marking technology
-  Type-wheel marking technology
-  Laser-marking technology
-  Traceability
-  Special-purpose machines

Application area

BORRIES numbering heads are used to mark consecutive numbers, series and model designations on almost all plastically deformable materials. The area of application ranges from individual production to integration in rotary indexing tables or transfer lines.

Optional equipment

In addition to our standard range, we supply all kinds of special designs, such as numbering heads with:

- Special circuits
- Special engravings
- Integrated type holders
- Pneumatic switching devices (with electronic switch detection)
- Nickel-plated marker wheels
- Hot marking version

Conventional marking technology

Scribe, stylus and dot-peening marking technology

Type-wheel marking technology

Laser-marking technology

Traceability

Special-purpose machines

ANPW numbering head

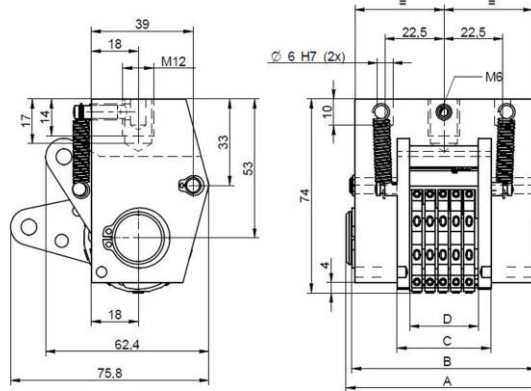

Cage	Size 1	Size 2	Size 3	Size 4	Size 5	Size 6
Dimension A	62	68	75	82	92	105
Dimension B	55	61	68	75	85	98
Dimension C	23	29	36	43	53	66

Cage dimension C = imprint width D + (>) 10 mm



Character height	Medium font standard								Semi-narrow font								Close-spaced font								Number of digits (Marker wheels)					
	10 pitch								10 pitch								10 pitch													
Dimension D = Imprint width	3.7	5	6	7	9	11	13	17	2	2.5	3	4	5	6	8	2	2.5	3	4	5	6	8	2	3.7	5	6	7	9	11	2
	5.9	8	9.5	11	14	17	20	26	5.9	8	9.5	11	14	17	20	5.9	5.9	8	9.5	11	14	17	3							
	8.1	11	13	15	19	23	27	35	8.1	11	13	15	19	23	27	8.1	8.1	11	13	15	19	23	4							
	10.3	14	16.5	19	24	29	34	44	10.3	14	16.5	19	24	29	34	10.3	10.3	14	16.5	19	24	29	5							
	12.5	17	20	23	29	35	41	53	12.5	17	20	23	29	35	41	12.5	12.5	17	20	23	29	35	6							
	14.7	20	23.5	27	34	41	48	14.7	20	23.5	27	34	41	48	14.7	14.7	20	23.5	27	34	41	7								
	16.9	23	27	31	39	47	16.9	23	27	31	39	47	16.9	16.9	23	27	31	39	47	8										
	19.1	26	30.5	35	44	53	19.1	26	30.5	35	44	53	19.1	19.1	26	30.5	35	44	53	9										
	21.3	29	34	39	49	21.3	29	34	39	49	21.3	29	34	39	49	21.3	21.3	29	34	39	49	10								

Example: With a character height of 4 mm in the font "Medium font standard" with 5 digits, the result is an imprint width D of 24 mm and therefore box size 3 can be selected (grey background).

Conventional marking technology

Scribe, stylus and dot-peening marking technology

Type-wheel marking technology

Laser-marking technology

Traceability

Special-purpose machines

TNPW numbering head

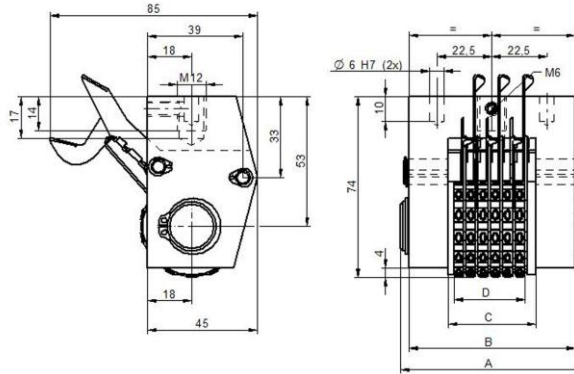

Cage	Size 1	Size 2	Size 3	Size 4	Size 5	Size 6
Dimension A	62	68	75	82	92	105
Dimension B	55	61	68	75	85	98
Dimension C	23	29	36	43	53	66

Cage dimension C = imprint width D + (>) 2 mm



	Medium font standard								Semi-narrow font								Close-spaced font								Number of digits (marker wheels)					
	14 pitch				11				14 pitch				11				14 pitch				11									
Character height	1.5	2	2.5	3	4	5	6	8	2	2.5	3	4	5	6	8	2	2.5	3	4	5	6	8	2	2.5	3	4	5	6	8	
Dimension D = Imprint width	4	5	6	7	9	11	13	17	4	5	6	7	9	11	13	4	4	5	6	7	9	11	4	4	5	6	7	9	11	2
	6.5	8	9.5	11	14	17	20	26	6.5	8	9.5	11	14	17	20	6.5	6.5	8	9.5	11	14	17	6.5	6.5	8	9.5	11	14	17	3
	9	11	13	15	19	23	27	35	9	11	13	15	19	23	27	9	9	11	13	15	19	23	9	9	11	13	15	19	23	4
	11.5	14	16.5	19	24	29	34	44	11.5	14	16.5	19	24	29	34	11.5	11.5	14	16.5	19	24	29	11.5	11.5	14	16.5	19	24	29	5
	14	17	20	23	29	35	41	53	14	17	20	23	29	35	41	14	14	17	20	23	29	35	14	14	17	20	23	29	35	6
	16.5	20	23.5	27	34	41	48	62	16.5	20	23.5	27	34	41	48	16.5	16.5	20	23.5	27	34	41	16.5	16.5	20	23.5	27	34	41	7
	19	23	27	31	39	47	55	19	23	27	31	39	47	55	19	19	23	27	31	39	47	19	19	23	27	31	39	47	8	
	21.5	26	30.5	35	44	53	62	21.5	26	30.5	35	44	53	62	21.5	21.5	26	30.5	35	44	53	21.5	21.5	26	30.5	35	44	53	9	
24	29	34	39	49	59	24	29	34	39	49	59	24	24	29	34	39	49	59	24	24	29	34	39	49	59	10				

Example: With a character height of 4 mm in the font "Medium font standard" with 5 digits, the result is an imprint width D of 24 mm and therefore box size 2 must be selected (grey background).

Conventional marking technology

Scribe, stylus and dot-peening marking technology

Type-wheel marking technology

Laser-marking technology

Traceability

Special-purpose machines

VNPW numbering head

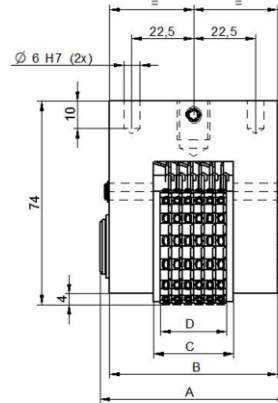
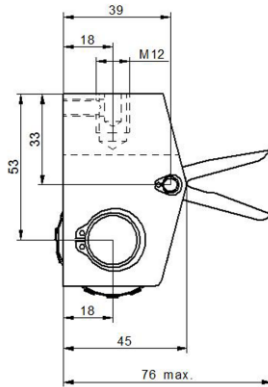



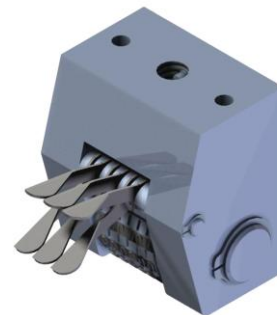



Cage	Size 1	Size 2	Size 3	Size 4	Size 5	Size 6
Dimension A	62	68	75	82	92	105
Dimension B	55	61	68	75	85	98
Dimension C	23	29	36	43	53	66



	Medium font standard								Semi-narrow font								Close-spaced font								Number of digits (marker wheels)
	15 pitch				13	11	15 pitch				13	11	15 pitch				13	11							
Charakter height	1.5	2	2.5	3	4	5	6	8	2	2.5	3	4	5	6	8	2	2.5	3	4	5	6	8	2		
Dimension D = Imprint width	3	4	5	6	8	11	13	17	3	4	5	6	8	9	13	3	3	4	5	7	8	11	2		
	4.5	6	7.5	9	12	17	20	26	4.5	6	7.5	9	12.5	14	20	4.5	4.5	6	7.5	11	12.5	17	3		
	6	8	10	12	16	23	27	35	6	8	10	12	17	19	27	6	6	8	10	15	17	23	4		
	7.5	10	12.5	15	20	29	34	44	7.5	10	12.5	15	21.5	24	34	7.5	7.5	10	12.5	19	21.5	29	5		
	9	12	15	18	24	35	41	53	9	12	15	18	26	29	41	9	9	12	15	23	26	35	6		
	10.5	14	17.5	21	28	41	48	62	10.5	14	17.5	21	30.5	34	48	10.5	10.5	14	17.5	27	30.5	41	7		
	12	16	20	24	32	47	55	12	16	20	24	35	39	55	12	12	16	20	31	35	47	8			
	13.5	18	22.5	27	36	53	62	13.5	18	22.5	27	39.5	44	62	13.5	13.5	18	22.5	35	39.5	53	9			
15	20	25	30	40	59	15	20	25	30	44	49	15	15	20	25	39	44	59	10						

Example: With a character height of 3 mm in the font "Medium font standard" with 5 digits, the result is an imprint width D of 15 mm and therefore box size 1. must be selected (grey background).

-  Conventional marking technology
-  Scribe, stylus and dot-peening marking technology
-  Type-wheel marking technology
-  Laser-marking technology
-  Traceability
-  Special-purpose machines

MNPW numbering head

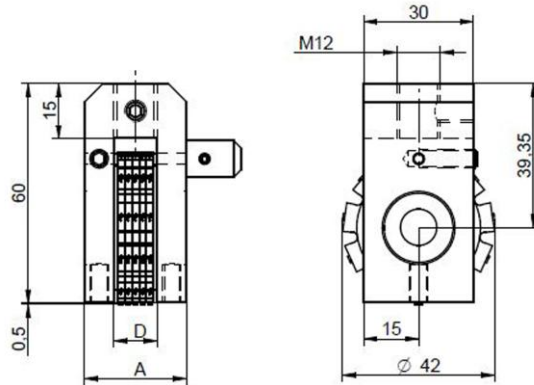

Cage	Size 1	Size 2
Dimension A	28	40
Dimension D	12	24



	Medium font standard						Semi-narrow font					Close-spaced font					Number of digits (marker wheels)
	15 pitch						15 pitch					15 pitch					
Character height	1.5	2	2.5	3	4	5	2	2.5	3	4	5	2	2.5	3	4	5	2 3 4 5 6 7 8 9 10
Dimension D = Imprint width	3	4	5	6	8	12	3	4	5	6	9	3	3	4	5	8	
	4.5	6	7.5	9	12	18	4.5	6	7.5	9	13.5	4.5	4.5	6	7.5	12	
	6	8	10	12	16	24	6	8	10	12	18	6	6	8	10	16	
	7.5	10	12.5	15	20	7.5	10	12.5	15	22.5	7.5	7.5	10	12.5	20		
	9	12	15	18	24	9	12	15	18	9	9	12	15	24			
	10.5	14	17.5	21	10.5	14	17.5	21	10.5	10.5	14	17.5					
	12	16	20	24	12	16	20	24	12	12	16	20					
	13.5	8	22.5	13.5	18	22.5	13.5	13.5	18	22.5							
15	20	15	20	15	15	20											

Example: With a character height of 3 mm in the font "Medium font standard" with 5 digits, the result is an imprint width D of 15 mm and so box size 2 can be selected (appears on a grey background)

Subject to technical changes.